

OXYFIX C-90 MB 17-20 EH (2)

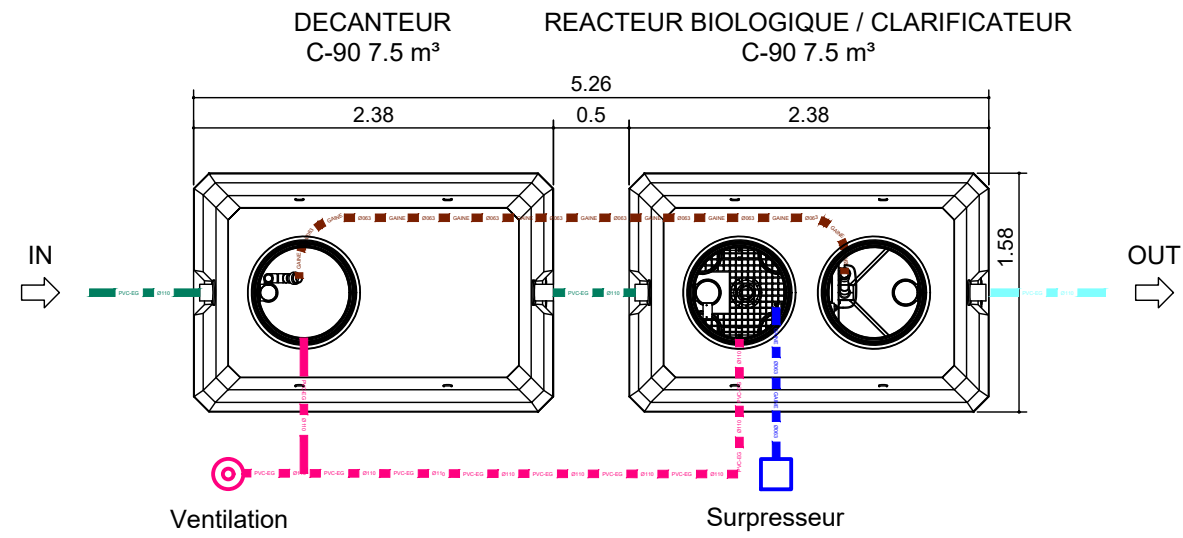

REMARQUES:

1. **Conditions de pose:**
Merci de lire attentivement le guide de mise en œuvre avant toute installation !!
2. **Tolérances sur les dimensions:**
2%
3. **Option(s):**
Tuyauterie, rehausses, trappillons et accessoires en option.

LEGENDE TUYAUTERIE	
Nature du produit véhiculé (couleur)	
■	Eau usée
■	Eau traitée
■	Boue
■	Air surpressé
■	Ventilation
■	Gaine électrique

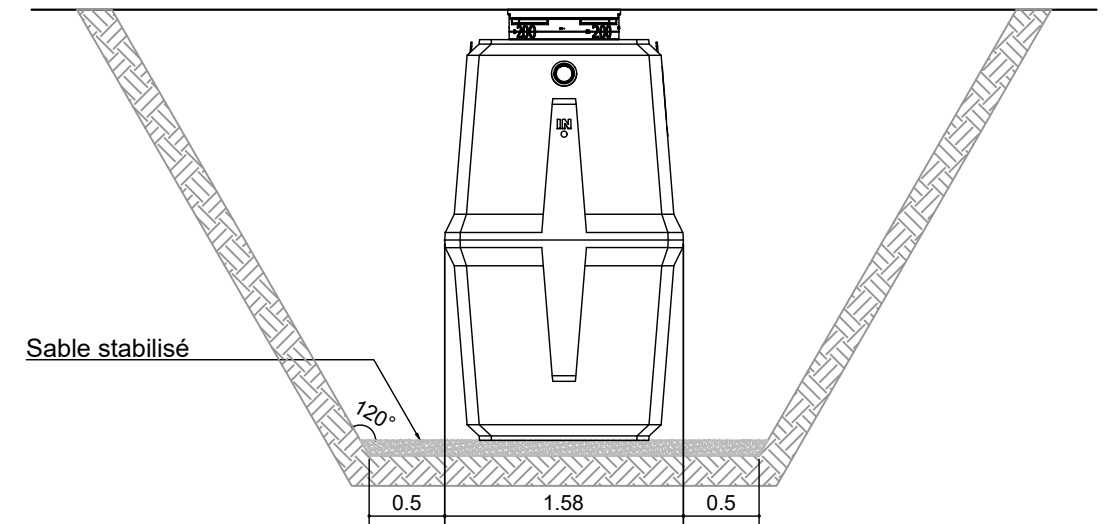
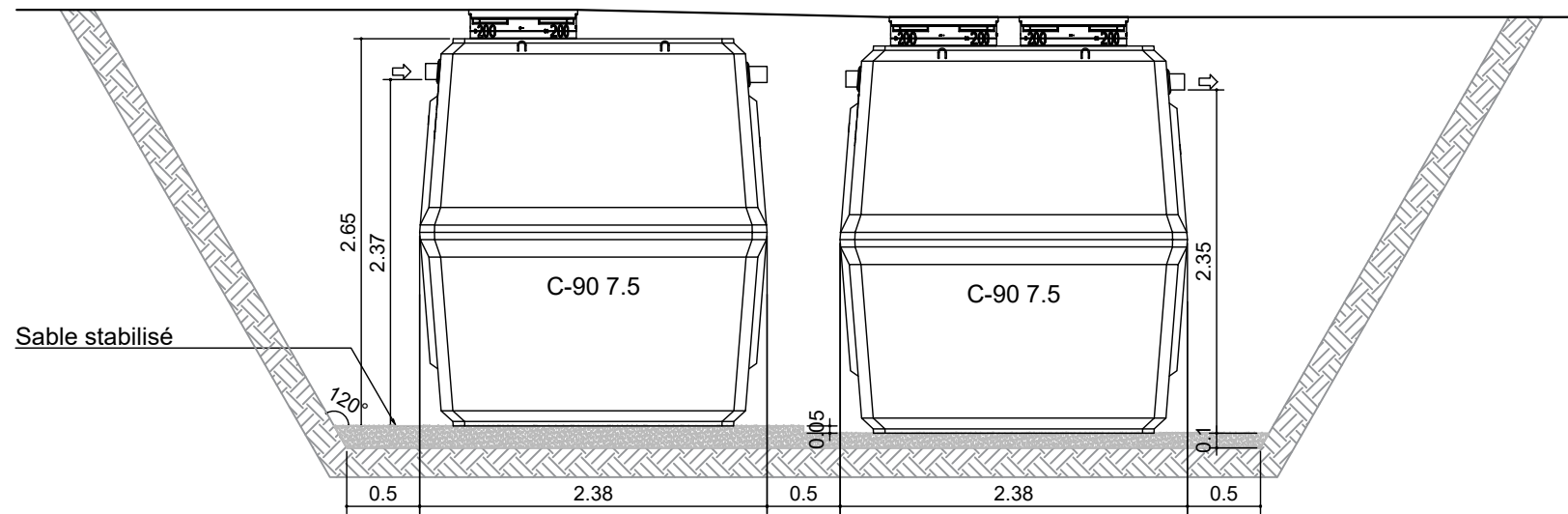

A	Released	15/02/2021	PHIC		
Rev	DESCRIPTIONS	DATE	DESIGNER	VERIFIED BY	VALIDED BY

eloy water

Zoning de Damré, rue des Spinettes 13
4140 Sprimont (BELGIUM)
Tel: +32(0)4/382.34.44
<http://www.eloywater.com> - info@eloywater.com

OXYFIX C-90 MB 17-20 EH (2) / 3.00 m³/jour					
Plan d'implantation					
GAMME STANDARD		1/50	A3	STATUT	
OXYFIX TP	EW-1482-020-I01-FR.dwg				