

WATERBUFFER C-90 15 m³ - Buffer 3.6 m³

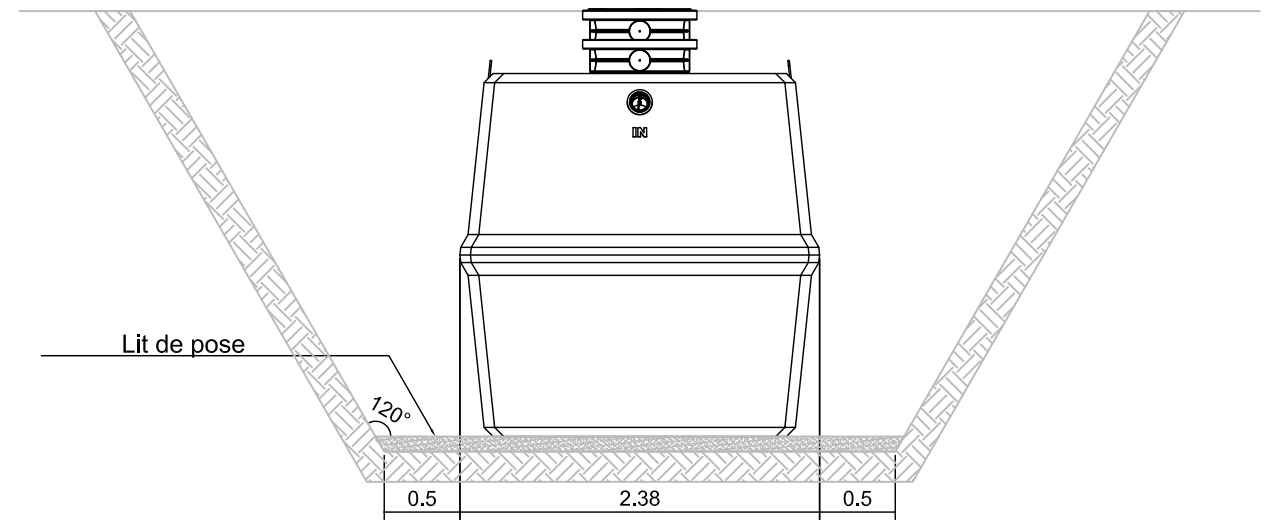
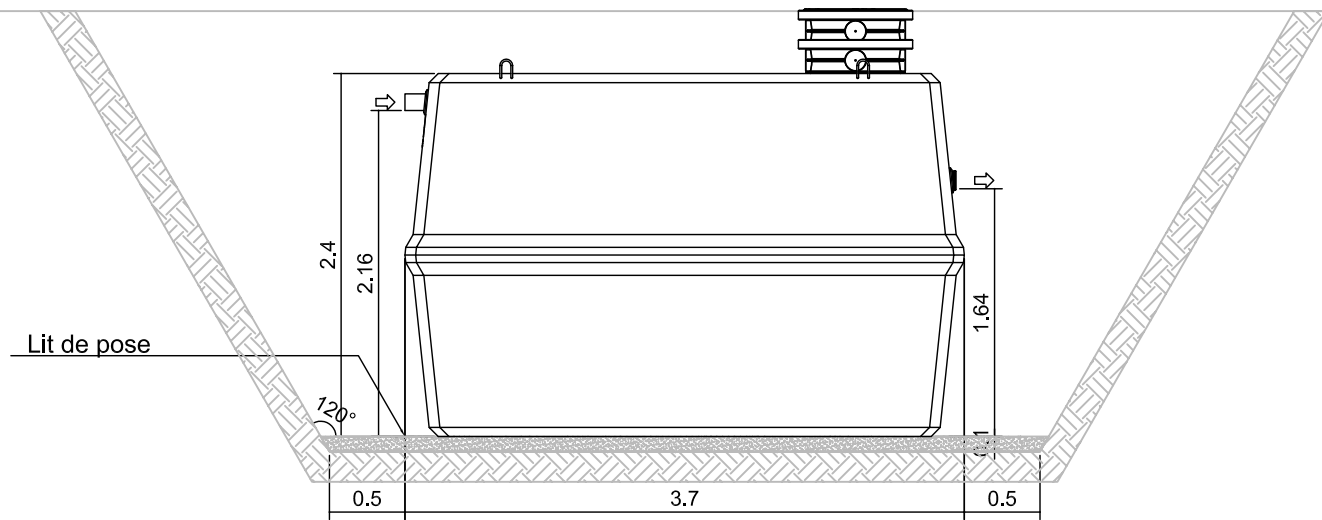
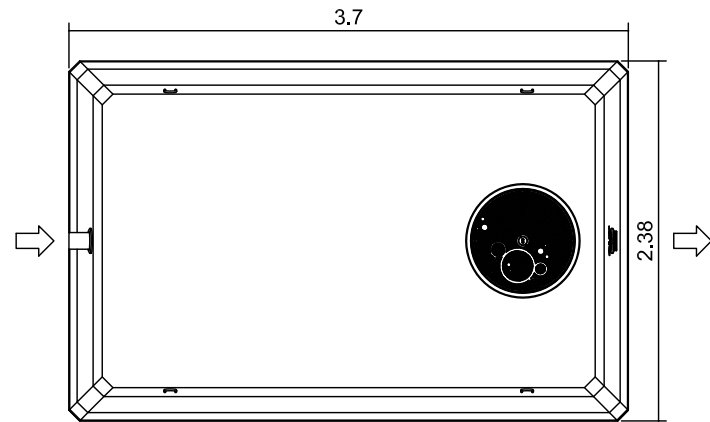

DATE	INDICES	MODIFICATIONS	VALIDATION		
05-04-2016	A	Adaptation sortie OUT	Dressé par: P. Hick	Vérifié par: O. Lisin	Validé par: X. Maertens

eloy water

Zoning de Damré, rue des Spinettes 13
4140 Sprimont (BELGIUM)
Tel: +32(0)4/382.44.00 - Fax: +32(0)4/382.44.01
<http://www.eloywater.com> - info@eloywater.com

WATERBUFFER C-90 15 m ³ - Buffer 3.6 m ³ Monocuve Plan Guide d'Implantation			
GAMME STANDARD ELOY WATERBUFFER EUROPE	Echelles 1/50	Date 06/04/2016	Feuille A3
EW-174	R	150 I011	A-