

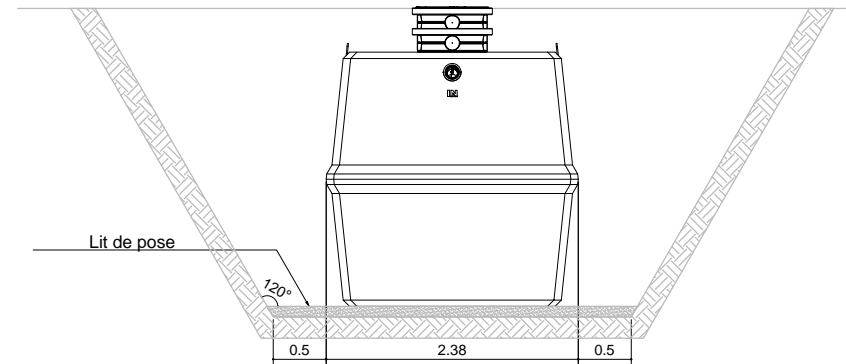

WATERBUFFER C-90 20 m³ - Buffer 2.4 m³

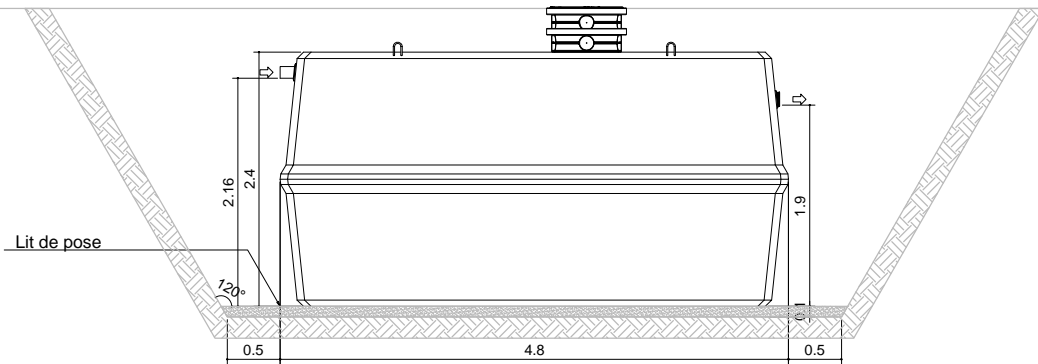
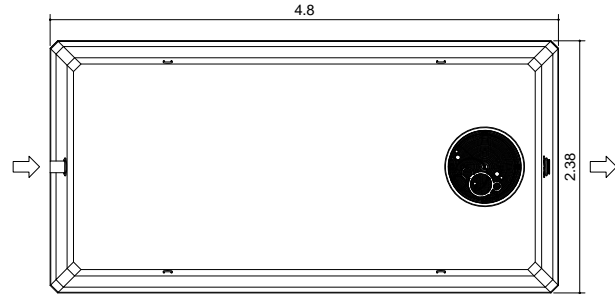

DATE	INDICES	MODIFICATIONS	VALIDATION		
			Dressé par: P. Hick	Vérfié par: O. Lisin	Validé par: X. Maertens

 Zoning de Darné, rue des Spinettes 13 4140 Sprimont (BELGIUM) Tel: +32(0)4/382.44.00 - Fax: +32(0)4/382.44.01 http://www.eloywater.com - info@eloywater.com	WATERBUFFER C-90 20 m ³ - Buffer 2.4 m ³ Monocuve Plan Guide d'Implantation		
	GAMME STANDARD ELOY WATERBUFFER EUROPE	Echelles 1/50 EW- 174	Date 21/01/2016 R 200 I001